



**STRIMAXX & FRIENDS**  
Textile Promotion Products

## News about Strimaxx

Since 2018, we have concentrated sales, logistics and printing at our headquarters in Renchen. We redesigned our website [www.strimaxx.de](http://www.strimaxx.de) and started with a successful relaunch in summer. Innovative, chic umbrella models complete our range.

Everything in proven Top-Strimaxx quality. Let yourself be inspired by our new catalogue.

## The MAXX Reverso Cover picture



### Standing independently

Due to the arrangement of its umbrella tips the MAXX Reverso stands independently.



### Upside-down effect

Closes inversely and stands out with its special upside-down effect.



### Double coverage

Different inside and outside cover: available from stock in blue, orange, red, light green, light blue and yellow.



### Wet umbrella cover inside

The special construction of the MAXX Reverso covers the wet umbrella fabric inside.

More information: page 5

# Content

<b>NEW</b> MAXX Collection.....	page 4	Business bags.....	page 32
Concierge Umbrella.....	page 7, 21	Specials.....	page 34
<b>NEW</b> Regular umbrellas.....	page 12	Garment bags.....	page 36
Midsized-Regular Umbrella.....	page 19, 20	Bags.....	page 38
XXL-umbrellas.....	page 22	Hotel program.....	page 42
Collapsible umbrellas.....	page 23	Advertising space.....	page 46
Backpacks.....	page 28		

## Program-Highlights



### **NEW** The snazzy MAXX

Our brand new model: Elegant and modern regular umbrella. Windproof frame, completely made of fibreglass. Also available in current fashion colours page 4.

page 4



### **RetroMAXX**

See and be seen. The umbrella VIPs trust in. Try out yourself and understand why many fashion magazines have already reported enthusiastically.

page 9



### **Little MAXX**

Double advertising due to the extra-wide and printable closure band, ultra flat like a smartphone, ultra strong by using high-quality materials and nevertheless an ultra light umbrella (160g).

page 12

# The snazzy MAXX



Item.-No.  
1051



black



navy



red



Available in 56 trendy fashion colours from 500 pcs.,  
delivery time approx. 95 days.



10 mm fibreglass shaft, fibreglass frame



190T Polyester-Pongee



Plastic, black



Automatic



8 ribs



88 cm



460 g



108 cm



20 pieces



Panel



Closure band

# MAXX Reverso



Stands independently.

Item-No.  
1050



navy



red



orange



yellow



light blue



light green



10 mm metal shaft in black/FRP-frame



Premium 190T Polyester-Pongee, with perforation in X-form,  
Individual perforation possible for custom-made products (e. g. Logo)



Plastic, black



Automatic



8 ribs



80 cm



510 g



105 cm



24 pieces



Panel

# MAXX City



Item-No.  
1049



black



navy



light grey



red



blue



white



dark green



bordeaux



10 mm metal shaft/fibreglass frame



Polyester



Wood



Automatic



8 ribs



83 cm



370 g



95 cm



Windproof



48 pieces



Panel



Closure band

# MAXX Active

# Economy MAXX

The Master of Price and Performance



Item-No. 1048

- 01 black
- 02 navy
- 03 light grey
- 04 red
- 07 blue
- 08 white

Item-No. 1047

- 01 black
- 02 navy
- 03 light grey
- 04 red
- 07 blue
- 08 white (handle and top additionally white)
- 09 dark green
- 10 yellow
- 14 4-colour
- 31 bordeaux

10 mm metal shaft/fibreglass frame

Polyester

Wood

Automatic

8 ribs

81 cm

320 g

95 cm

Windproof

48 pieces



Panel



Closure band

10 mm metal shaft, metal/fibreglass frame

Polyester

Plastic, black  
Art. 1047-08 (white): handle/ top are additionally white

Automatic

8 ribs

82 cm

370 g

95 cm

Windproof

48 pieces



Panel



Closure band

Regular umbrellas

XXL-umbrellas

Collapsible umbrellas

Backpacks

Business bags

Specials

Garment bags

Bags

Hotel program

Advertising space



# ClassicMAXX

## The Concierge Umbrella



Item-No.  
1046

01

black

02

navy

08

white



16 mm wooden shaft, metal/fibreglass frame



Polyester-Pongee, Teflon coated



Wood



Manual



8 ribs



105 cm



620 g



130 cm



Windproof



36 pieces



Panel



Closure band

## This you should know about the umbrella

The good old things still exist.

The Classic MAXX is the father of all Grand Hotel Concierge umbrellas.

A robust (16cm) wooden shaft, 130cm diameter, ideal for two persons and perfect for all situations when you need a big, classic umbrella—heavy rain and a stretch limo stops in front of a 5\*\*\*\*\* Hotel, a celebrity walks the red carpet, or the bride needs to get to the church in her wedding dress crossing the street.







# RetroMAXX

Super Stylish – Super Chic



Item-No. 98  
1044  
transparent

 14 mm wooden shaft, fibreglass frame

 POE, transparent

 Wood

 Manual

 8 ribs

 89 cm

 445 g

 92 cm

 Windproof

 24 pieces

 Panel

 Closure band

 Doming

Regular  
umbrellas

XXL-umbrellas

Collapsible  
umbrellas

Backpacks

Business bags

Specials

Garment bags

Bags

Hotel program

Advertising  
space

## What are the unique features?

The Retro MAXX is something special, voted by several fashion magazines to be a „hip“ and stylish accessory. This umbrella is a real eye-catcher, even if it is not raining. The elegant shoulder strap, means it can be easily and elegantly carried when not in use.



# Fair MAXX













Perfect – Stylish



Item-No.  
1042

01

black

-  10mm metal shaft, metal/fibreglass frame
-  Polyester Pongee
-  ABS soft-touch
-  Automatic
-  8 ribs
-  82 cm
-  395 g
-  105 cm
-  Windproof
-  48 pieces
-  Panel
-  Closure band

## This you should know about the umbrella

Fair MAXX is a beautifully designed, precision made standard umbrella matching, from the top, through the matt black handle with elegant button and shaft, to the tips of its fibreglass ribs.

## What are the unique features?

Fair MAXX is the perfect umbrella. Beautifully designed, elegant, colour accessorised, with perfect automatic open/close technique.















# Clap MAXX

Ultra Engineering – Ultra Comfortable



One hand double closing automatic.  
Legally protected.

Item-No. 1043  
01 02  
black navy

-  Alu/fibreglass frame, 3-section telescopic
-  Polyester Pongee, Teflon coated
-  ABS soft-touch, black
-  Double closing automatic
-  8 ribs
-  29 cm
-  290 g
-  97 cm
-  Windproof
-  36 pieces
-  Panel
-  Cover
-  Closure band

## This you should know about the umbrella

Practical handling combined with one of the best innovations since umbrellas were invented. The Clap MAXX doesn't only spare packing together wet umbrellas but also time and nerves in bad weather.

## What are the unique features?

Normally umbrellas fold only in width automatically. The Clap MAXX is able to return to its small starting position by pushing a button. To prevent the umbrella of folding accidentally the closing button is set into the end of the handle and can only be released after pulling it back.



Watch here:  
[www.klappmaxx.de](http://www.klappmaxx.de)













# Little MAXX

Ultra Flat – Ultra Light – Ultra Strong



Size comparable with a smartphone.

Item-No. 1039 **01**  
black

-  Metal/fibreglass frame, 3-section telescopic
-  Special Light Pongee, Teflon coated
-  12 mm ABS soft-touch
-  Manual
-  6 ribs
-  22 cm
-  159 g
-  87 cm
-  48 pieces
-  Panel
-  Cover
-  Closure band













# Pocket MAXX

The Beauty for the Bag



Pocket umbrella of the „Fair MAXX“ (S. 9). With thumb protection when opening or closing the umbrella.

Item-No. 1041 **01**  
black

-  Metal/fibreglass frame, 3-section telescopic
-  Polyester Pongee
-  ABS soft touch
-  Manual
-  8 ribs
-  24 cm
-  272 g
-  98 cm
-  Windproof
-  48 pieces
-  Panel
-  Cover
-  Closure band

# Alu-Regular Umbrella

Automatic



Reflector tape at the edge



Item-No.  
1012



black



orange



yellow



light blue

# Regular Umbrella

Automatic



Item-No.  
1014



black



navy



red

- 14 mm aluminium shaft, fibreglass frame
- Polyester-Pongee
- EVA sponge, colour matching
- Automatic
- 8 ribs
- 84 cm
- 450 g
- 105 cm
- Windproof
- 48 pieces
- Panel
- Closure band

- 10 mm metal shaft, fibreglass frame
- Polyester-Pongee
- ABS soft-touch, black
- Automatic
- 8 ribs
- 87 cm
- 491 g
- 105 cm
- Windproof
- 48 pieces
- Panel
- Closure band

# Regular Umbrella

Automatic



Item-No.  
1015



black navy

# Regular Umbrella













Automatic















Item-No.  
1018



black navy light grey blue white

-  14 mm fibreglass shaft, fibreglass frame
  -  Polyester-Pongee
  -  ABS Soft Touch, black
  -  Automatic
  -  8 ribs
  -  88 cm
  -  492 g
  -  105 cm
  -  Windproof
  -  48 pieces
-  Panel
-  Closure band

-  10 mm metal shaft, fibreglass frame
  -  Polyester-Pongee
  -  EVA sponge, black
  -  Automatic
  -  8 ribs
  -  83 cm
  -  390 g
  -  105 cm
  -  Windproof
  -  48 pieces
-  Panel
-  Closure band



# Alu Regular Umbrella

Automatic



Item-No. 1019

01 black   02 navy   07 blue

-  14mm aluminium shaft, metal/fibreglass frame
-  Polyester-Pongee, Teflon coated
-  Aluminium
-  Automatic
-  8 ribs
-  85 cm
-  415 g
-  Doming
-  Panel
-  Windproof
-  48 pieces
-  Closure band









# Alu Regular Umbrella

Automatic



Item-No. 1020

01 black   02 navy   03 light grey   04 red

-  14mm aluminium shaft, metal/fibreglass frame
-  Polyester-Pongee, Teflon coated
-  Aluminium
-  Automatic
-  8 ribs
-  89 cm
-  412 g
-  Doming
-  Panel
-  Windproof
-  48 pieces
-  Closure band















# Alu Regular Umbrella

Automatic



Item-No.  
1021



-  14 mm aluminium shaft, metal frame
-  Polyester-Pongee
-  EVA sponge, colour matching
-  Automatic
-  8 ribs
-  83 cm
-  412 g
-  Doming
-  105 cm
-  Panel
-  48 pieces
-  Closure band













# Alu Regular Umbrella

Automatic



Item-No.  
1022



-  14 mm aluminium shaft, metal frame
-  Laminated Polyester
-  EVA sponge, colour matching
-  Automatic
-  8 ribs
-  83 cm
-  412 g
-  Doming
-  105 cm
-  Panel
-  48 pieces
-  Closure band

# Alu Regular Umbrella

Automatik



- Item-No. 1023
- 01 black
  - 02 navy
  - 04 red
  - 08 white

- 14 mm aluminium shaft, metal frame
  - Polyester-Pongee
  - Aluminium
  - Automatic
  - 8 ribs
  - 89 cm
  - 394 g
  - 105 cm
  - 48 pieces
- Panel
 Closure band

# Alu Regular Umbrella

Automatic



Reflector tape at the edge



- Item-No. 1025
- 01 black
  - 02 navy

- 14 mm aluminium shaft, metal frame
  - Polyester-Pongee
  - Aluminium
  - Automatic
  - 8 ribs
  - 89 cm
  - 400 g
  - 105 cm
  - 48 pieces
- Panel
 Closure band

# Wooden Regular Umbrella

Automatic



Reflector tape at the edge



Item-No. 1024  
 01 02  
 black navy

# Wooden Regular Umbrella

Automatic



Item-No. 1026  
 01 02 03  
 black navy light grey

- 14 mm wooden shaft, metal frame
- Polyester-Pongee
- Wood
- Automatic
- 8 ribs
- 89 cm
- 445 g
- 105 cm
- 48 pieces
- Panel
- Closure band

- 14 mm wooden shaft, metal/fibreglass frame
- Polyester-Pongee, Teflon coated
- Wood
- Automatic
- 8 ribs
- 89 cm
- 442 g
- 105 cm
- Windproof
- 48 pieces
- Panel
- Closure band

# Wooden Regular Umbrella

Automatic



Item-No.  
1027



black



navy



white



dark green

- 14 mm wooden shaft, metal frame
- Polyester-Pongee
- Wood
- Automatic
- 8 ribs
- 89 cm
- 421 g
- 105 cm
- 48 pieces
- Panel
- Closure band

# Midsize-Regular Umbrella

Automatic



Item-No.  
1031



black



navy



light grey

- 12 mm fibreglass shaft, fibreglass frame
- Polyester-Pongee, Teflon coated
- ABS soft-touch, integrated push-button, black
- Automatic
- 8 ribs
- 92 cm
- 571 g
- 120 cm
- 36 pieces
- Windproof
- Panel
- Closure band

# Midsize-Regular Umbrella

Automatic













Item-No. 1032   
silver/













# Midsize-Regular Umbrella

Automatic



Item-No. 1033   
black navy light grey dark green

-  14 mm aluminium shaft, metal/fibreglass frame
-  Polyester
-  Plastic, integrated push-button, colour matching
-  Automatic
-  8 ribs
-  94 cm
-  480 g
-  Doming
-  Panel
-  36 pieces
-  Closure band

-  14 mm fibreglass shaft, metal/fibreglass frame
-  Polyester-Pongee, Teflon coated
-  Ebonite, black
-  Automatic
-  8 ribs
-  88 cm
-  623 g
-  Doming
-  Panel
-  Windproof
-  36 pieces
-  Closure band













# Golf & Guest Umbrella

Automatic



Item-No.  
1035

- 01  
black
- 02  
navy
- 07  
blue













-  14 mm fibreglass shaft, fibreglass frame
  -  Polyester-Pongee, Teflon coated
  -  EVA sponge, black
  -  Automatic
  -  8 ribs
  -  94 cm
  -  555 g
  -  Ø 130 cm
  -  Windproof
  -  36 pieces
-  Panel
  -  Closure band

# Golf & Guest Umbrella



Item-No.  
1036













- 01  
black
- 02  
navy

-  14 mm fibreglass shaft, fibreglass frame
  -  Polyester-Pongee
  -  EVA sponge, black
  -  Manual
  -  8 ribs
  -  97 cm
  -  440 g
  -  Ø 130 cm
  -  Windproof
  -  36 pieces
-  Panel
  -  Closure band

# Oversize Umbrella XXL



Item-No. 1034  
01  
 black

-  14 mm fibreglass shaft, fibreglass frame
-  Polyester-Pongee
-  ABS soft-touch, black
-  Manual
-  8 ribs
-  105 cm
-  678 g
-  140 cm
-  Windproof
-  36 pieces
-  Panel
-  Closure band

# Competiveness

We offer an ideal service package to our customers:

We use our existing know-how concerning textile production, technology – including screen printing – and global sourcing.

Thereby achieving scaled-down prices from which our customers benefit.

In summary: very good service, superior level of quality – even with manufacture of lesser items – and attractive costs. In addition a great stock programme comprising telescopic, regular, shoulder and XXL-umbrellas amongst others.

We consistently deliver stock orders, with printing, within a few days, according to your wishes. The scope of supply and services is from complete containers to individual orders delivered by messenger service.

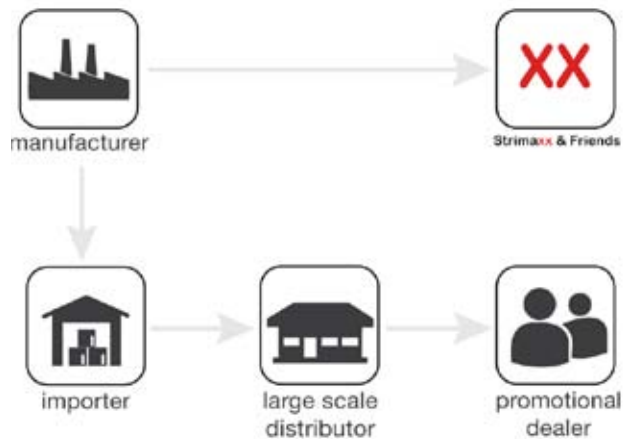



# Alu-Light Telescopic Umbrella

Automatic open/close



Item-No.  
1002



navy



blue



dark green

# Alu-Light Telescopic Umbrella

Automatic open/close



Item-No.  
1003



black



navy















light grey















red



dark green

-  Alu/fibreglass frame, 3-section telescopic
-  Polyester-Pongee, Teflon coated
-  ABS soft-touch, colour matching
-  Automatic open/close
-  8 ribs
-  29 cm
-  290 g
-  95 cm
-  Windproof
-  36 pieces
-  Panel
-  Cover
-  Closure band

-  Alu/fibreglass frame, 3-section telescopic
-  Polyester-Pongee, Teflon coated
-  ABS soft-touch, black
-  Automatic open/close
-  8 ribs
-  29 cm
-  290 g
-  95 cm
-  Windproof
-  36 pieces
-  Panel
-  Cover
-  Closure band

# Alu-Light Telescopic Umbrella

Automatic open/close



Item-No. 1004  
01  
black













# Alu-Light Telescopic Umbrella

Automatic open/close



Item-No. 1005  
01  
black

-  Alu/fibreglass frame, 3-section telescopic
-  Polyester-Pongee, Teflon coated
-  Plastic
-  Automatic open/close
-  8 ribs
-  27 cm
-  290 g
-  Doming
-  Panel
-  95 cm
-  Cover
-  Windproof
-  36 pieces
-  Closure band

-  Alu/fibreglass frame, 3-section telescopic
-  Polyester-Pongee, Teflon coated
-  ABS soft-touch
-  Automatic open/close
-  8 ribs
-  34 cm
-  350 g
-  Panel
-  95 cm
-  Cover
-  Windproof
-  36 pieces
-  Closure band

# Alu-Light Telescopic Umbrella    Alu-Light Telescopic Umbrella















Automatic

Automatic



Item-No. 1006  
01   02  
 black   navy

Item-No. 1007  
01   02   03   04   07   09  
 black   navy   light grey   red   blue   dark green

-  Alu/fibreglass frame, 3-section telescopic
-  Polyester-Pongee, Teflon coated
-  ABS soft-touch, black
-  Automatic
-  8 ribs
-  31 cm
-  260 g
-  95 cm
-  Windproof
-  36 pieces
-  Doming
-  Panel
-  Cover
-  Closure band

-  Alu/fibreglass frame, 3-section telescopic
-  Polyester-Pongee, Teflon coated
-  Plastic
-  Automatic
-  8 ribs
-  27 cm
-  260 g
-  95 cm
-  Windproof
-  pieces
-  Doming
-  Panel
-  Cover
-  Closure band

# Alu-Light Telescopic Umbrella



Item-No.  
1008

- 01 black
- 02 navy
- 03 light grey
- 06 orange
- 07 blue
- 08 white
- 09 dark green
- 12 light blue
- 13 light green

-  Alu/fibreglass frame, 3-section telescopic
-  Polyester-Pongee, Teflon coated
-  Plastic
-  Manual
-  8 ribs
-  25 cm
-  200 g
-  95 cm
-  Windproof
-  36 pieces
-  Doming
-  Panel
-  Cover
-  Closure band













# Alu-Light Telescopic Umbrella

Automatic



Item-No.  
1010

- 02 navy

-  Metal shaft, 2-section telescopic
-  Polyester
-  Plastic, colour matching
-  Automatic
-  8 ribs
-  36 cm
-  270 g
-  95 cm
-  Windproof
-  60 pieces
-  Panel
-  Cover
-  Closure band



## No limits in design **Individual All-over-Designs**



On request we offer umbrellas with all over photoprint, print art, print covering two panels or each panel.  
Important for you:  
Allround-Service from design to result.







## City-Backpack

Item-No.  
2012-01



black/red



Doming

- Big main compartment with zip
- Inner pocket with velcro closure and zip pocket
- Removable keyholder
- Zip pocket on backside
- 2 adjustable textile shoulder straps
- Metal plate for Doming or engraving, size approx. 4 cm x 2 cm
- Color: black/red with black/red handle
- Inside grey/black



outside: 300D Nylon, Rip-stop,  
inside: 210D/PU Nylon



27 cm (w) x 33 cm (h) x 15 cm (d)



25 pieces





# Backpack

Item-No.  
2016-01



black/red



Doming

- Color black with red applications
- Ebonite handle
- 2 big main compartments with 2-way zip and padded laptop pocket
- Front compartment with 2-way zip, inside pocket and front pocket with 2-way zip
- Inside compartment and zip pocket outside
- Backside padded with breathable material
- Upholstered shoulder straps with reflector tapes and net pocket with elastic band
- Bottom compartment with rain hood
- 2 side pockets with 2-way zip
- Metal plate for doming or engraving, size approx. 4 cm x 2 cm



outside: 1680D Nylon  
inside: 210D Nylon/PU



30 cm (w) x 50 cm (h) x 30 cm (d)



25 pieces







## Backpack

Item-No.  
2006



black red/ black blue/ black

- Big main compartment with inner pocket
- Big front pocket with zip
- 2 front pockets with zip
- Net compartments on both sides
- 2 additional shoulder straps
- Upholstered shoulder straps with adjustable breast strap



1680 D Polyester, PVC



approx. 28 x 47 x 16 cm



VE 25 pieces



## Backpack

Item-No.  
2007



black red/ black blue/ black grey/ black

- Upholstered inner compartment for notebook
- Big front compartment with zip and 3 inner pockets
- Front pocket with zip
- Net part with elastic band and several inner pockets e.g. for headphones
- Net compartments on both sides
- Upholstered back
- Upholstered shoulder straps and adjustable breast strap



300 D Rip-stop Polyester, PVC



approx. 29 x 44,5 x 18 cm



VE 25 pieces



## Backpack

Item-No.  
2011-01

01

black

- Big main compartment with zip
- Front compartment with front zip pocket
- Net pockets for bottles with elastic band on both sides
- Padded shoulder straps



600 D Polyester, PVC



approx. 34 cm (w) x 43 cm (h) x 25 cm (d)



VE 25 pieces

## Backpack

Item-No.  
2010

76

grey/  
black

- Big main compartment with inner pocket
- Big front pocket with zip
- Net part with zip
- Upholstered back
- Tension belts at the side
- Upholstered shoulder strap and adjustable breast waist strap



600 D Polyester, PVC



approx. 30 x 46 x 19 cm



VE 25 pieces





## Laptop-Bag

Item-No. **01**  
2015-01  
black

- Outside pockets on front and backside
- Zip pocket on front side
- Big main compartment with zip
- 2 handles
- adjustable textile shoulder strap with shoulder pad



-  outside: 2-tone Nylon  
inside: 210D Nylon
-  approx. 39 cm (w) x 31 cm (h) x 5 cm (d)
-  40 pieces







## Shoulder Bag for Tablet PC

Item-No.  
2014-76

01

black

- Zip front pocket with red lining
- Pocket on backside with velcro closure
- Main compartment with padded inner compartment for Tablet PC with velcro closure
- Net zip pocket inside
- Adjustable textile shoulder strap with shoulder pad



outside: soft touch PU  
inside: 210D Nylon



approx. 22 cm (w) x 29 cm (h) x 5 cm (d)



25 pieces





## Custom orders

Sollte wir einmal kein ideales Produkt aus unserem Sortiment anbieten können - kein Problem, wir nehmen gern Herausforderungen an: Was wir nicht auf Lager haben, fertigen wir an!

Unsere Mitarbeiter und Entwickler wissen, worauf es ankommt und können Sie fachmännisch beraten.

Hierbei spielt es keine Rolle, um welche Größen, Materialien oder besonderen Einsatzgebiete es sich handelt. Durch unsere hauseigene Produktion ist ein fachübergreifendes Arbeiten möglich, was gerade bei Neuentwicklungen für ein durchdachtes - und im Ergebnis perfekten- Produkt wichtig ist. Kurze Kommunikationswege sorgen für einen reibungslosen Ablauf und dem Austausch von Fachwissen zwischen Produktentwicklung, Design, Einkauf, Vertrieb, Produktion, Druckveredelung und Logistik.

**Unsere Stärke:** Sinnvolle Produktlösungen, die bis ins Detail geplant sind und alle Anforderungen berücksichtigen, die der Nutzer hat –oder haben könnte.

Wenden Sie sich an unsere Mitarbeiter, die Sie gern unverbindlich beraten.



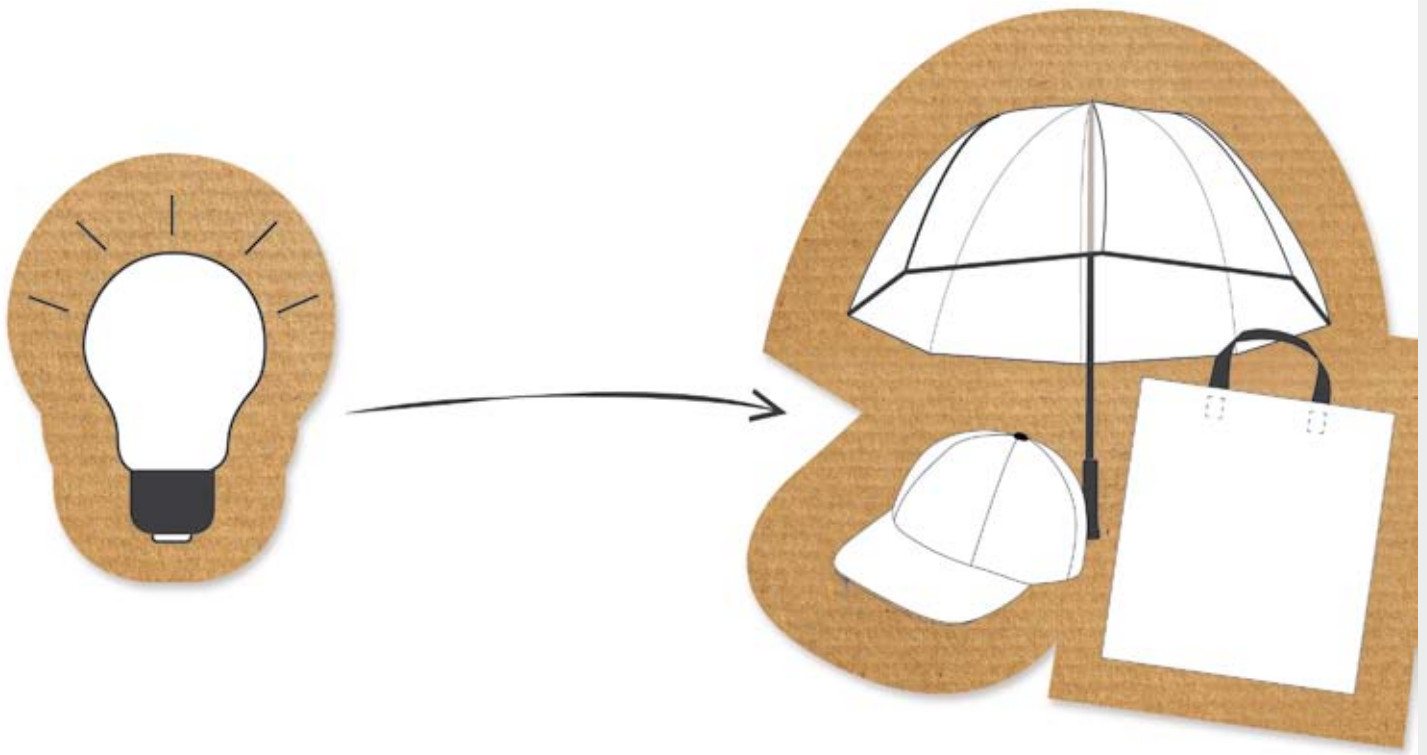

## Your reliable Manufacturer and Importer of Textile Promotion Goods – 8 convincing arguments

- We also manufacture ourselves: We can do many articles in our own German production site :
- Tailor made orders – fast orders – small orders-samples
- We assist to develop your ideas and design your layout
- Decades of experience with imports from Asia
- Regular overseas production site visits
- All import procedures & customs clearance
- Delivery in time
- We offer logistic services, domestic printing
- Very competitive price/performance

## Classic Suit Cover



Item-No. 1335 01 08  
black white



Non woven (50g)



60x100 cm, 60x135 cm or 60x165 cm



100 pieces

## Suit Cover with Shirt Pocket



extra shirt pocket on the backside

Item-No. 2898 01 09 28  
black dark night sky  
green blue



Non woven (75g)



65x110x6 cm



50 pieces

## Suit Cover with Handles



Item-No. 4566 01  
black



Non woven (75g)



65x125x6 cm



50 pieces

## Suit Cover - Transparent



Item-No. 2348 98  
transparent



PE-material (0,08 mm)



60x135 cm or 60x100 cm



100 pieces



# Luxury Garment Bag



Item-No.  
2501

01

black

- Outside of high-quality, soft Polyester 1680 D texture
- Inside breathable canvas/cotton
- Strong zip
- Handle and push button inside



Outside high-quality, soft polyester



approx. 65 x 125 cm



10 pieces



Our garment bags have the look and feel of baggage from leading brand manufacturers, due to the use of high quality material and the excellent workmanship.

More colours on request.

## Cotton Bag



Item-No.  
3001



100 % Cotton



2 short handles



approx. 38 x 42 cm



VE 300 pieces

## Cotton Bag



Item-No.  
3004



100 % Cotton



2 short handles



approx. 38 x 42 cm



VE 300 pieces

## Cotton Bag



Item-No.  
3002



100 % Cotton



2 long shoulder straps



approx. 38 x 42 cm



300 pieces

## Cotton Bag



Item-No.  
3005



100 % Cotton



2 long shoulder straps



approx. 38 x 42 cm







300 pieces

## Shoe Bag with closing Cord







Item-No. 3003 **18**  
natural

-  100 % Cotton
-  With string
-  approx. 28 x 40 cm
-  500 pieces

## Cotton Bag



Item-No. 3006 **18**  
natural





-  100 % Cotton
-  1 long shoulder strap
-  approx. 22 x 31 cm
-  500 pieces

## Shopping Bag – classic



Item-No. 4001

<b>01</b>	<b>08</b>	<b>19</b>	<b>20</b>	<b>21</b>	<b>22</b>
black	white	champagne	khaki	lime	dark green
<b>23</b>	<b>24</b>	<b>25</b>	<b>26</b>	<b>27</b>	<b>28</b>
poppy	ice pink	sunflower yellow	golden orange	sahara	night sky blue





-  PP non woven
-  2 short handles
-  approx. 38 x 42 cm
-  250 pieces

## Shopping Bag with Cord



Item-No. 4002

<b>01</b>	<b>08</b>	<b>22</b>	<b>28</b>	<b>29</b>
black	white	dark green	night sky blue	burgundy

-  PP non woven
-  2 long cords
-  approx. 42 x 38 x 10 cm
-  200 pieces

## Shopping Bag with small Pocket



Item-No. 4003

black/ champagne	dark green/ champagne	night sky blue/ champagne	coffee/ champagne	burgundy champagne

- PP non woven
- 2 long shoulder straps
- approx. 42 x 33 x 15
- 200 pieces

## Bag with long Handles



Item-No. 4004

black	white	dark green	poppy	deep sapphire blue

- PP non woven
- 2 long shoulder straps
- approx. 38 x 42 cm
- 250 pieces

## Re-Usable Bag with Seam



Item-No. 4005

deep sapphire blue	poppy

- PP non woven
- 2 short handles
- approx. 38 x 42 cm
- 250 pieces

## Bag with bottom Gusset



Item-No. 4006

white	poppy





- PP non woven
- 2 short handles
- approx. 38 x 42 cm
- 250 pieces

## Bag with Grip-hole



Item-No. 4007

<b>01</b>	<b>08</b>	<b>23</b>
black	white	poppy





-  PP non woven
-  Punched grip-hole
-  approx. 28 x 33,5 cm
-  250 pieces

## PP Bag with bottom Gusset



Item-No. 4008

<b>01</b>	<b>30</b>
black	deep sapphire blue





-  PP non woven
-  Punched grip-hole
-  approx. 35,5 x 37 x 13 cm
-  250 pieces

## Small Pharmacy Bag



Item-No. 4009

<b>01</b>	<b>23</b>
black	poppy





-  PP non woven
-  2 short handles
-  approx. 22 x 26 cm
-  500 pieces

## Large Bag



Item-No. 4011

<b>01</b>	<b>08</b>
black	white

-  PP non woven
-  2 short handles
-  approx. 50 x 50 cm
-  250 pieces





## Hotel program of Strimaxx & Friends

Apart from umbrellas (from p. 4) and garment bags (from p. 36) which can be printed individually for hotels, we also manufacture many other products according to individual customer requirements.



### Slippers & Hotel Guest Shoes

Hotel slippers or hotel guest shoes are a classic product among accessories and are available in various qualities, shapes and colours. Also with anti-slip sole, closed or open toe.

Whether printed or with embroidery, we individualise your hotel slipper according to your wishes.



### Umbrellas

At Strimaxx you will find a large selection of umbrellas. Even budget umbrellas meet our high quality standards: as guest umbrella in hotel rooms or as a regular umbrella to take from the concierge desk, if your guests are surprised by bad weather.

Portiers also use umbrellas to protect guests from rain and snow on arrival or departure. We have the right model for you.



### Wash nets & laundry bags

We offer laundry bags and washing nets for hotel rooms in a large selection, in different sizes and colours. With individual printing, your washing nets and laundry bags are uniquely marked. For example, when hotel laundry is handed over

to external laundries for cleaning. This prevents mistakes and wrong allocation. Wash nets are a practical and gentle help.





### Cotton- and Non woven carrier bags

Our carrier bags are made of 100% cotton or 100% pure PP material, without fillers or other chemical additives. The bags are absolutely odourless and therefore also suitable for food.

A cheap, sustainable and ecologically harmless

advertising medium, which your guests will use for long.

A sustainable brand strengthening with little effort.



### Shoe bags & Shirt bags

Here, too, the following applies: you can positively surprise the guest with the little things of everyday hotel life. A cheap, but nevertheless beautiful and noble looking shirt bag.

Reliably protects every shirt and every blouse against

dirt and wrinkles. Ideally suited for cleaning in the hotel's own laundry. Your guest will always remember this when he takes his shirt or blouse out of this bag.



### Garment bags

A suit cover is a nice, good-looking and popular advertising medium for hotels. For the guest there is no other advertising medium with such a big difference between perceived value and the actually low cost.

Take advantage of our wide range of products: from simple, inexpensive clothes covers to luxury bags, which nevertheless cost much less than you and your guest would expect.

## Individual Service - Specials

### Services for our hotel customers:

- Broad product range for the hotel industry
- competent advice from experienced professionals
- Fast processing & punctual delivery
- On request call & logistics service
- Convincing price/performance ratio
- Individual production according to your wishes

### E. g. you are looking for:



- Large concierge umbrellas with individual printing for an event?
- Tablecloths in a special colour with print for a company presentation?
- Red aprons for a Christmas gala?

Call us or send us an email - what we do not have in stock, we will manufacture for you.

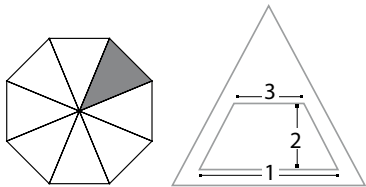
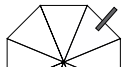

# Position of Logo

## Umbrellas

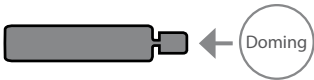
Position of Logo	Print size			
	1	2	3	
<p><b>Panel</b></p> 				
	Regular umbrellas	23,0	13,0	17,0
	Golf- & guest umbrellas	30,0	17,0	23,0
	Shoulder- & telescopic umbrellas	18,0	9,0	15,0
<p><b>Closure band</b></p> 	8,0 x 0,8 cm			
<p><b>On umbrella case</b></p> 	10,0 x 3,0 cm			
<p><b>Doming &amp; Laser engraving</b></p> 	on request			
<p><b>Transfer printing</b></p>	on request			

## Cotton Bags

Position of Logo

<p><b>Print size:</b>            approx. 25 cm width und 25 cm height,            depending on item            Transfer printing on request</p>

## PP non woven Bags

Position of Logo

<p><b>Print size:</b>            approx. 25 cm width und 25 cm height,            depending on item            Transfer printing on request</p>

## Bags & Backpacks



Important advice



News



Superior Price-/Performance



TOP Quality

## Quality and Know-How – what makes us unique

As an experienced producer we have the inside know-how. Every day we cut, sew and print cloth and other fabrics in our plant in Germany. This knowledge is combined with production of promotional textiles. In addition, contracted providers abroad produce for us, following our specifications.

Our philosophy: Even a plain, low-cost PP-bag has got to be an optical and tactile experience – neatly printed and finished – for something very valuable is at stake – your reputation.

## Important Notes

Colours, measurements and weight



The featured colours are without obligation and may differ from the original.

Information on measurements and weight are seen to be circa-statements, deviations may be possible. Declarations on colour by Pantone and HKS are produced according to C (Pantone) and K (HKS). A 100%-analogy with these scales cannot be guaranteed due to appearance and workmanship of the products. Subject to alterations in colour, optics and technology.

Transfer printing on demand. To enable cost proposal management we require the logo in original size for examination in advance.

Optional - at an extra cost we willingly provide you with samples of all our products.

We assume no liability for any errors.

## **STRIMAXX<sup>®</sup> & FRIENDS GmbH**

Carl-Benz-Straße 4a

D-77871 Renchen

T + 49 (0) 7843 - 995 71 - 50

F + 49 (0) 7843 - 995 71 - 60

[www.strimaxx.de](http://www.strimaxx.de) • [info@strimaxx.de](mailto:info@strimaxx.de)